

RoHS compliant

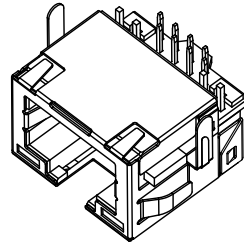
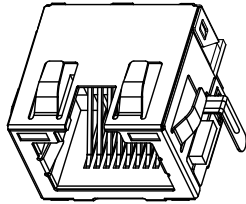
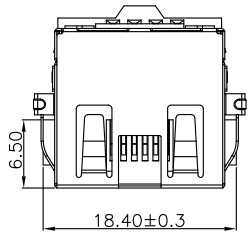

- NOTES:
1. HOUSING MATERIAL:GLASS FILLED POLYESTER UL94V-0.
  2. CONTACT MATERIAL:COPPER ALLOY,T=0.35.
  3. PLATING: GOLD PLATED ON CONTACT AREA, 100u"MIN.MATTE TIN PLATED ON SOLDERING AREA, 50u"MIN. NICKEL PLATED OVERALL.
  4. SHELL:COPPER ALLOY,T=0.20. 30u"MIN. NICKEL PLATED OVERALL.
  5. LED:T=0.50,MATE TIN PLATED.

- ELECTRICAL:
1. VOLTAGE RATING: 125V AC RMS.
  2. CURRENT RAIING: 1.5AMP.
  3. CONTACT RESISTANCE: 40MILLIOHMS MAX.
  4. INSULATION RESISTANCE: 500MEGOHMS MIN @100V DC.

- MECHANICAL:
1. DURRABILITY: 750 CYCLES MIN.
  - 2.INSERTION FORCE : 22N MAX.
  - 3.REMOVAL FORCE(WITHOUT PLUG LOCK) : 22N MAX.

- ENVIRONMENTAL:
1. STORAGE: -40°C~85°C
  2. OPERATION: -40°C~85°C
- \*Apply to the EU standards(ROSH)
1. ⑦ ⑭为QIP尺寸.

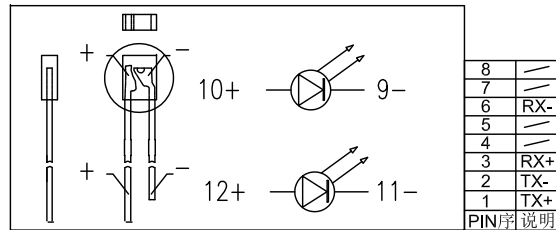
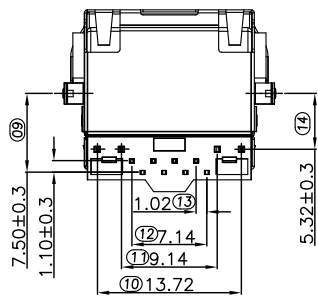
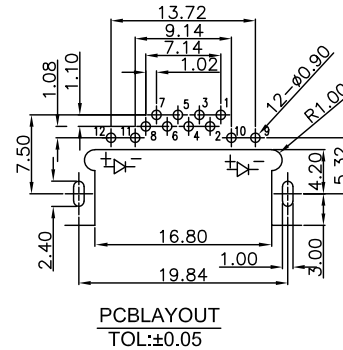
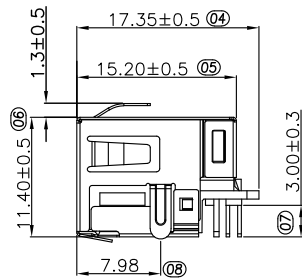
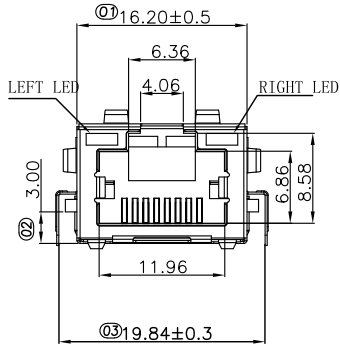

P/N:RJ58D-8811-2XX4X5X

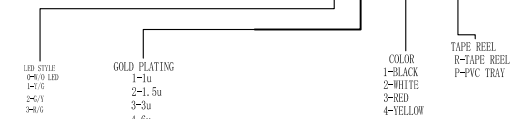

REV	ECN NO	DESCRIPTION	DATE	SIGNATURE	PROJECT	DRAWING NO	REV	A0	TITLE
A0		NEW DESIGN	2018/03/15						RJ45 8P8C 沉板3.0带弹带LED

**X-SHUN** 东莞市祥舜电子科技有限公司  
DONGGUAN X-SHUN ELECTRONIC TECHNOLOGY CO., LTD  
TEL:+86 769 81885389 FAX:+86 769 81887859  
E-Mail:sales@x-shun.com Http:www.x-shun.com

PART NO. RJ58D-8811-2XX4X5X