

RoHS compliant

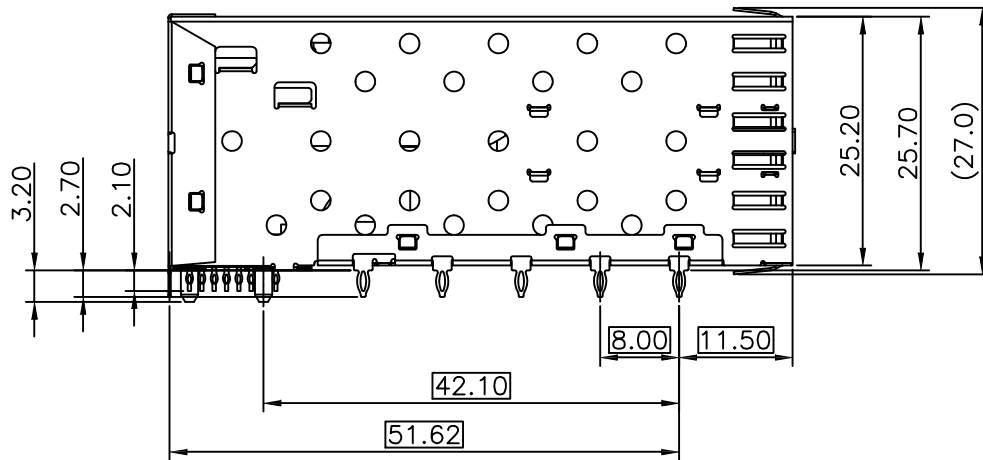
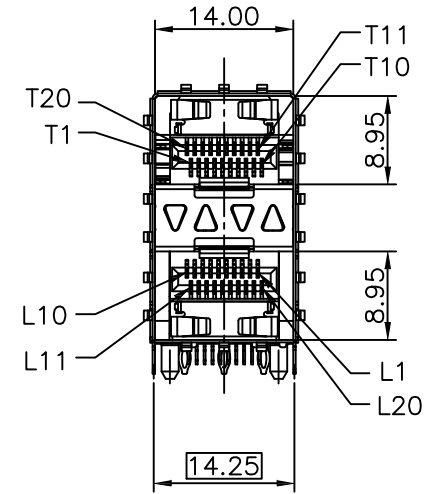
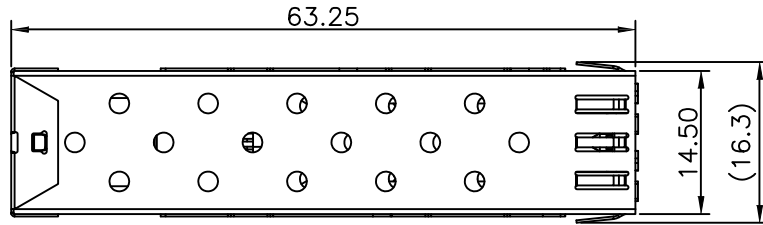

NOTES:

MATERIAL:  
 CAGE: NICKEL SILVER, THICKNESS 0.25mm  
 CONNECTOR:  
 PLASTIC HOUSING: HIGH TEMPERATURE LCP, UL94 V-0.  
 SPRING: STAINLESS STEEL, THICKNESS 0.20mm  
 CONTACTS: PHOSPHOR BRONZE, THICKNESS 0.20mm  
 PLATING: 15μ" MIN. GOLD ON MATING AREA,  
 150μ" MIN. MATE TIN ON SOLDER TAILS.

PACKAGING: TRAY PACKAGING.

TEMPERATURE RANGE: -40°C TO +85°C

				GENERAL TOLERANCE		DRAWN	<i>Gene Li</i>	2017/03/21	UNIT	MM	<b>X-SHUN</b> 东莞市祥舜电子科技有限公司 DONGGUAN X-SHUN ELECTRONICTECHNOLOGY CO., LTD TEL:+86 769 81885389 FAX:+86 769 81887859 E-Mail:sales@x-shun.com Http:www.x-shun.com
				.X ±0.35	X.° ± 2°	CHECKE	HYY	SCALE	1:1		
A0		NEW DESIGN	2017/03/21			APPROVE		SHEET	1/4	PART NO.	8001-21X015-01
REV	ECN NO	DESCRIPTION	DATE	SIGNATURE	PROJECT	DRAWING NO		REV	A0	TITLE	SFP 2X1 CAGE+CONNECTOR

RoHS compliant

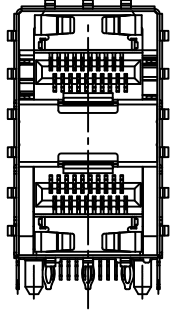

0:W/O Light Pipe

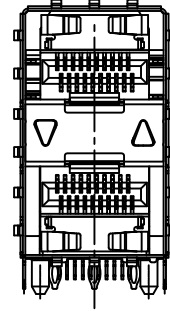

2:Outer Light Pipe

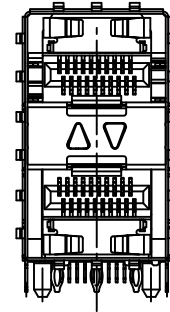
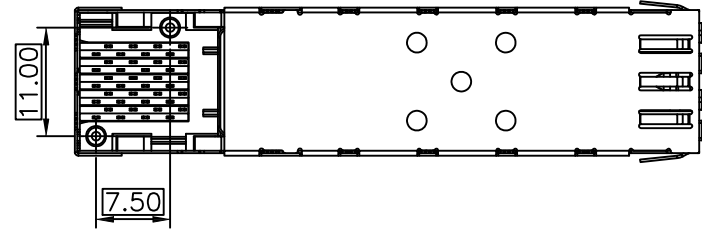

1:Inner Light Pipe

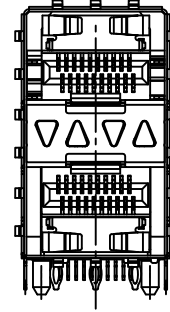

3:Inner+Outer Light Pipe

P/N:8001-21X015-01

- 0:W/O Light Pipe
- 1:Inner Light Pipe
- 2:Outer Light Pipe
- 3:Inner+Outer Light Pipe

				GENERAL TOLERANCE		DRAWN	<i>Gema Li</i>	2017/03/21	UNIT	MM	<b>X-SHUN</b> 东莞市祥舜电子科技有限公司 DONGGUAN X-SHUN ELECTRONIC TECHNOLOGY CO., LTD TEL:+86 769 81885389 FAX:+86 769 81887859 E-Mail:sales@x-shun.com Http:www.x-shun.com
				.X ±0.35	X.° ± 2°	CHECKE	HYY	SCALE	1:1		
A0		NEW DESIGN	2017/03/21			APPROVE		SHEET	2/4	PART NO.	8001-21X015-01
REV	ECN NO	DESCRIPTION	DATE	SIGNATURE	PROJECT	DRAWING NO		REV	A0	TITLE	SFP 2X1 CAGE+CONNECTOR

RoHS compliant

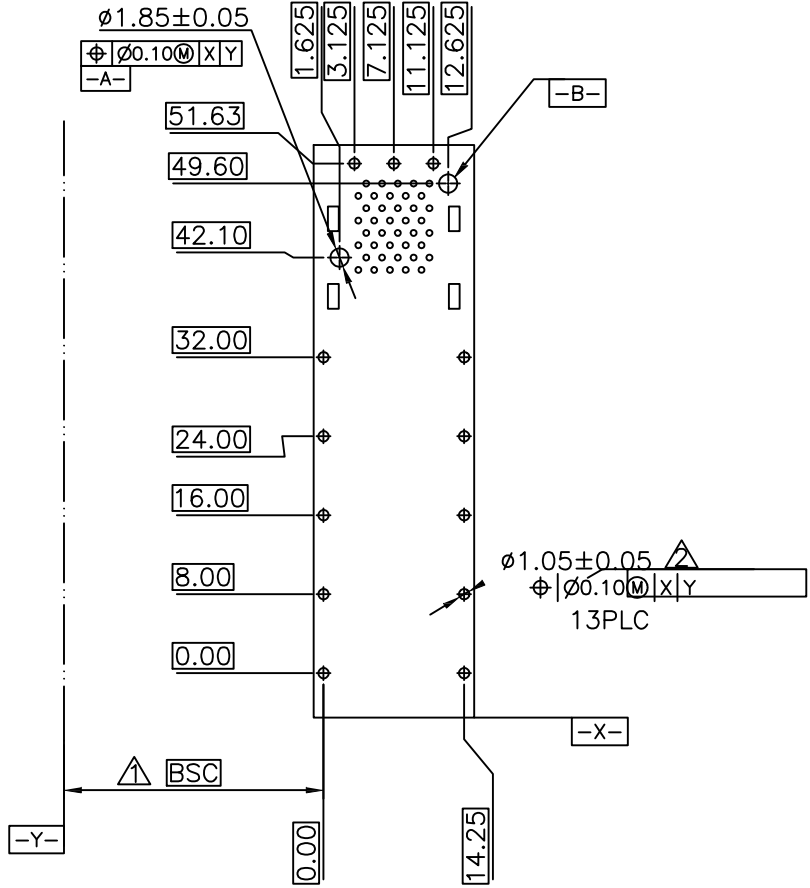

ECOMMENDED PCB CONFIGURATION

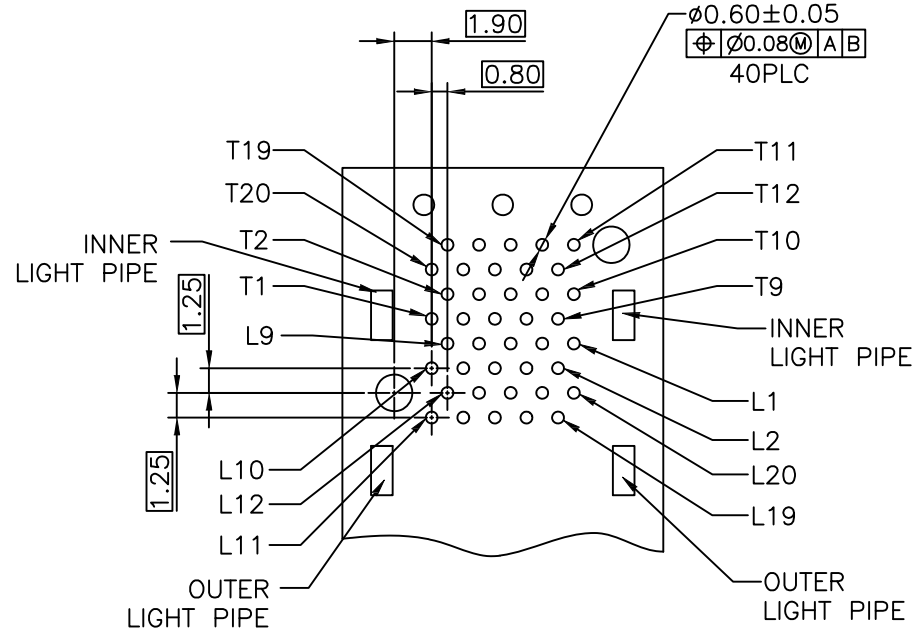

NOTES:

1. DATUM AND BASIC DIMENSIONS ESTABLISHED BY CUSTOMER.
2. 1.05 mm DIAMETER HOLES ARE CHASSIS GROUND .

				GENERAL TOLERANCE		DRAWN	<i>Gene Li</i>	2017/03/21	UNIT	MM	<b>X-SHUN</b> 东莞市祥舜电子科技有限公司 DONGGUAN X-SHUN ELECTRONIC TECHNOLOGY CO., LTD TEL:+86 769 81885389 FAX:+86 769 81887859 E-Mail:sales@x-shun.com Http:www.x-shun.com		
				.X	$\pm 0.35$	X. $^{\circ}$	$\pm 2^{\circ}$	CHECKE	HYY	SCALE		1:1	
				.XX	$\pm 0.25$	X. $^{\circ}$	$\pm 1^{\circ}$	APPROVE		SHEET	3/4	PART NO.	8001-21X015-01
REV	ECN NO	DESCRIPTION	DATE	SIGNATURE	PROJECT	DRAWING NO		REV	A0	TITLE	SFP 2X1 CAGE+CONNECTOR		

A

A

RoHS compliant

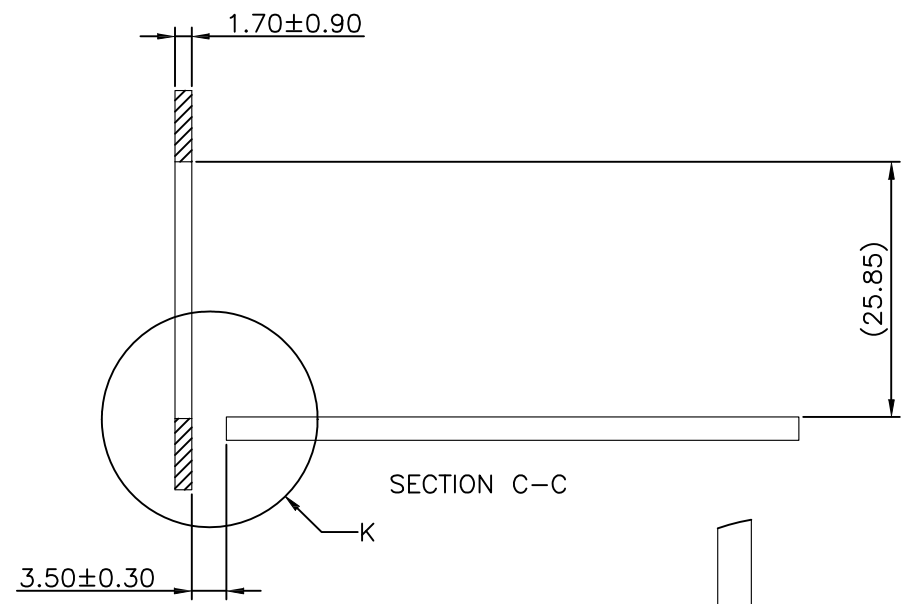
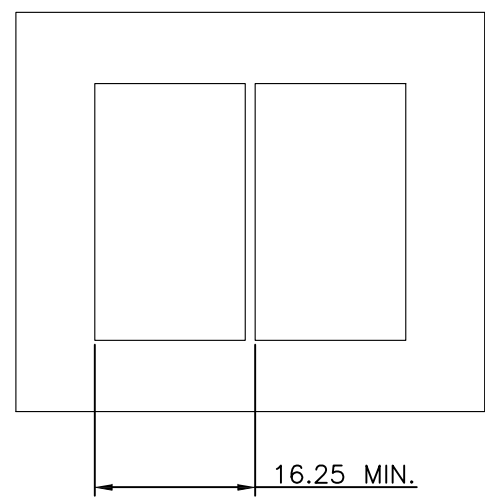
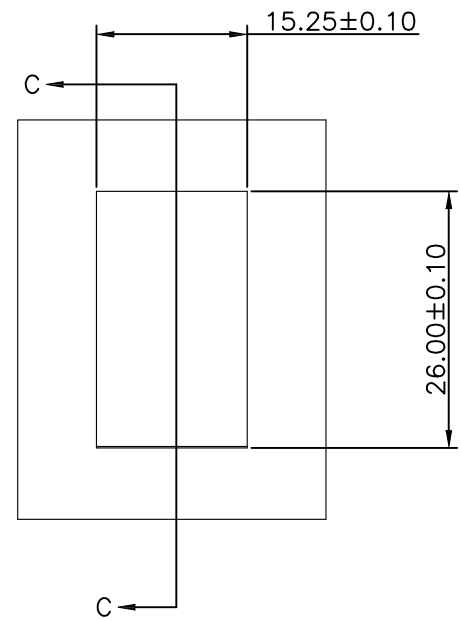

SECTION C-C

0.15±0.10  
(BEZEL CUTOUT BELOW PCB)

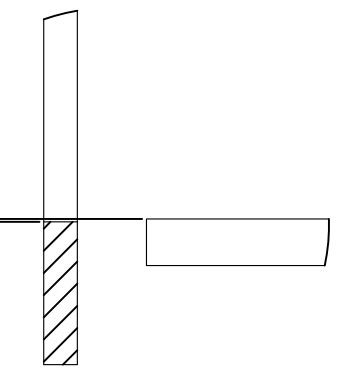

DETAIL K  
2:1

RECOMMENDED BEZEL DESIGN

				GENERAL TOLERANCE		DRAWN	<i>Gene Li</i>	2017/03/21	UNIT	MM	<b>X-SHUN</b> 东莞市祥舜电子科技有限公司 DONGGUAN X-SHUN ELECTRONICTECHNOLOGY CO., LTD TEL:+86 769 81885389 FAX:+86 769 81887859 E-Mail:sales@x-shun.com Http:www.x-shun.com		
				.X ±0.35	X.° ± 2°	CHECKE	HYY		SCALE	1:1	PART NO.	8001-21X015-01	
				.XX ±0.25	.X° ± 1°	APPROVE			SHEET	4/4	TITLE		SFP 2X1 CAGE+CONNECTOR
				.XXX ±0.15	.XX° ± 0.5°	PROJECT		DRAWING NO		REV	A0		
REV	ECN NO	DESCRIPTION	DATE	SIGNATURE	PROJECT		DRAWING NO		REV	A0	TITLE		SFP 2X1 CAGE+CONNECTOR

A

A