

RoHS compliant

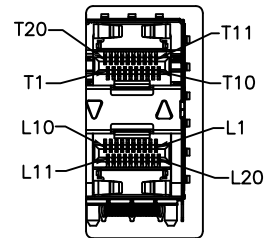
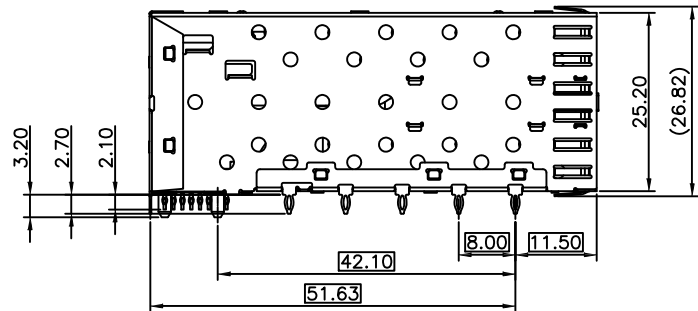
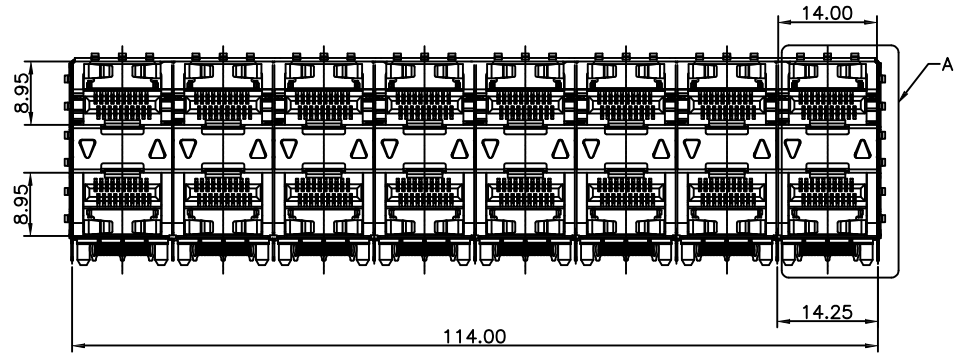
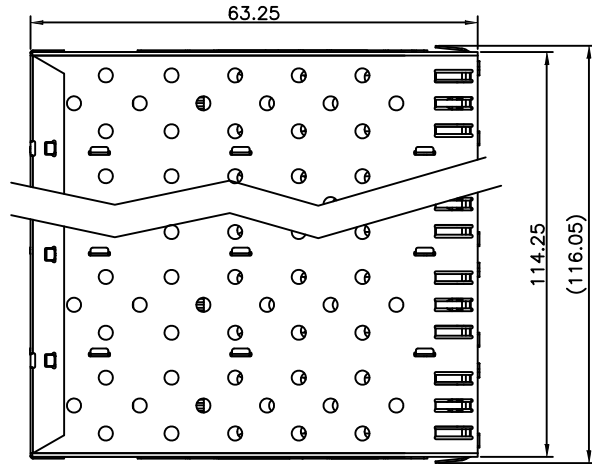

DETAIL A  
1:1

NOTES:

MATERIAL:  
CAGE: NICKEL SILVER

CONNECTOR:  
PLASTIC HOUSING: HIGH TEMPERATURE LCP, UL94 V-0.  
LIGHT PIPE: POLYCARBONATE; COLOR: CLEAR  
SPRING: STAINLESS STEEL  
CONTACTS: PHOSPHOR BRONZE  
CONTACT PLATING: 15u" MIN. GOLD ON MATING AREA,  
150u" MATTE TIN ON SOLDER TAILS

PACKAGING: TRAY PACKAGING.

TEMPERATURE RANGE: -40°C TO +85°C

				GENERAL TOLERANCE		DRAWN	<i>Sene Li</i>	2017/03/21	UNIT	MM	东莞市祥舜电子科技有限公司 DONGGUAN X-SHUN ELECTRONIC TECHNOLOGY CO., LTD TEL:+86 769 81885389 FAX:+86 769 81887859 E-Mail:sales@x-shun.com Http:www.x-shun.com
				.X ±0.35	X.° ± 2°	CHECKE	HYY	SCALE	1:1		
A0		NEW DESIGN	2017/03/21			APPROVE		SHEET	1/4	PART NO.	8001-28X015-01
REV	ECN NO	DESCRIPTION	DATE	SIGNATURE	PROJECT	DRAWING NO		REV	A0	TITLE	SFP 2X8 CAGE+CONNECTOR

RoHS compliant

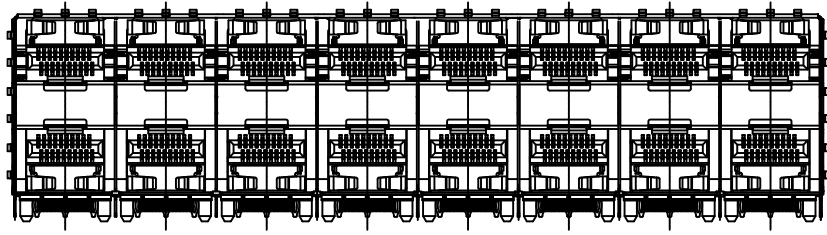

0:W/O Light Pipe

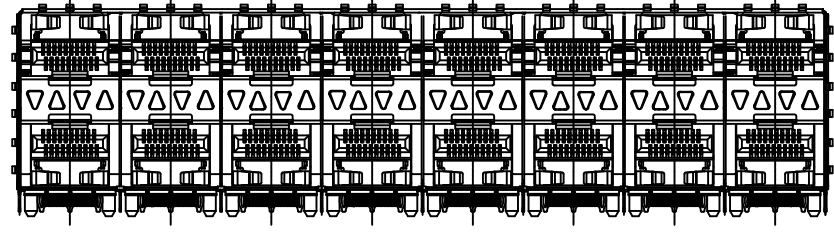

3:Inner+Outer Light Pipe

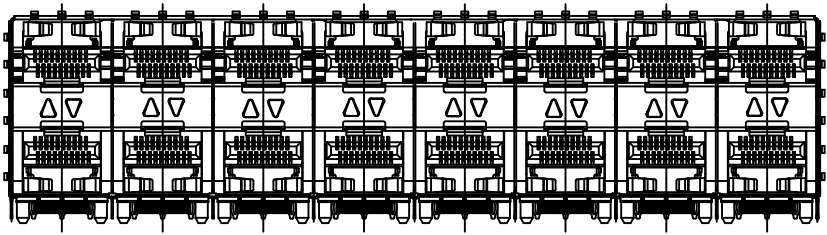

1:Inner Light Pipe

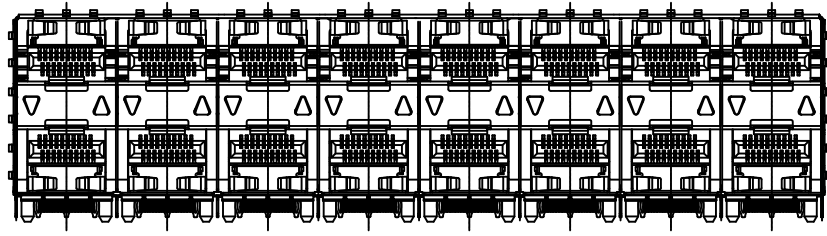

2:Outer Light Pipe

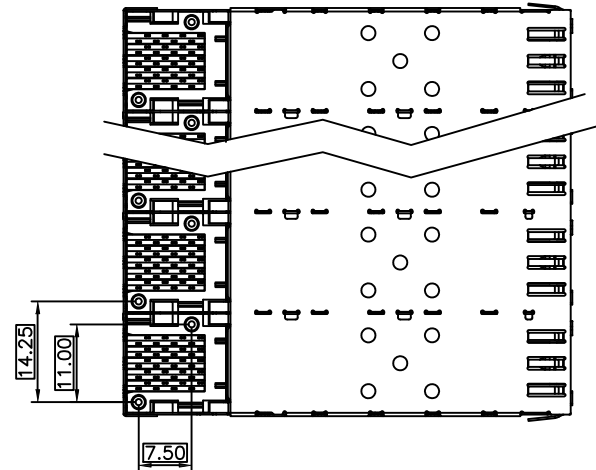

P/N:8001-28X015-01

- 0:W/O Light Pipe
- 1:Inner Light Pipe
- 2:Outer Light Pipe
- 3:Inner+Outer Light Pipe

				GENERAL TOLERANCE		DRAWN	<i>Geme Li</i>	2017/03/21	UNIT	MM	<b>X-SHUN</b> 东莞市祥舜电子科技有限公司 DONGGUAN X-SHUN ELECTRONICTECHNOLOGY CO., LTD TEL:+86 769 81885389 FAX:+86 769 81887859 E-Mail:sales@x-shun.com Http:www.x-shun.com
				.X ±0.35	X.° ± 2°	CHECKE	HYY	SCALE	1:1		
A0		NEW DESIGN	2017/03/21			APPROVE		SHEET	2/4	PART NO.	8001-28X015-01
REV	ECN NO	DESCRIPTION	DATE	SIGNATURE	PROJECT	DRAWING NO		REV	A0	TITLE	SFP 2X8 CAGE+CONNECTOR



RoHS compliant

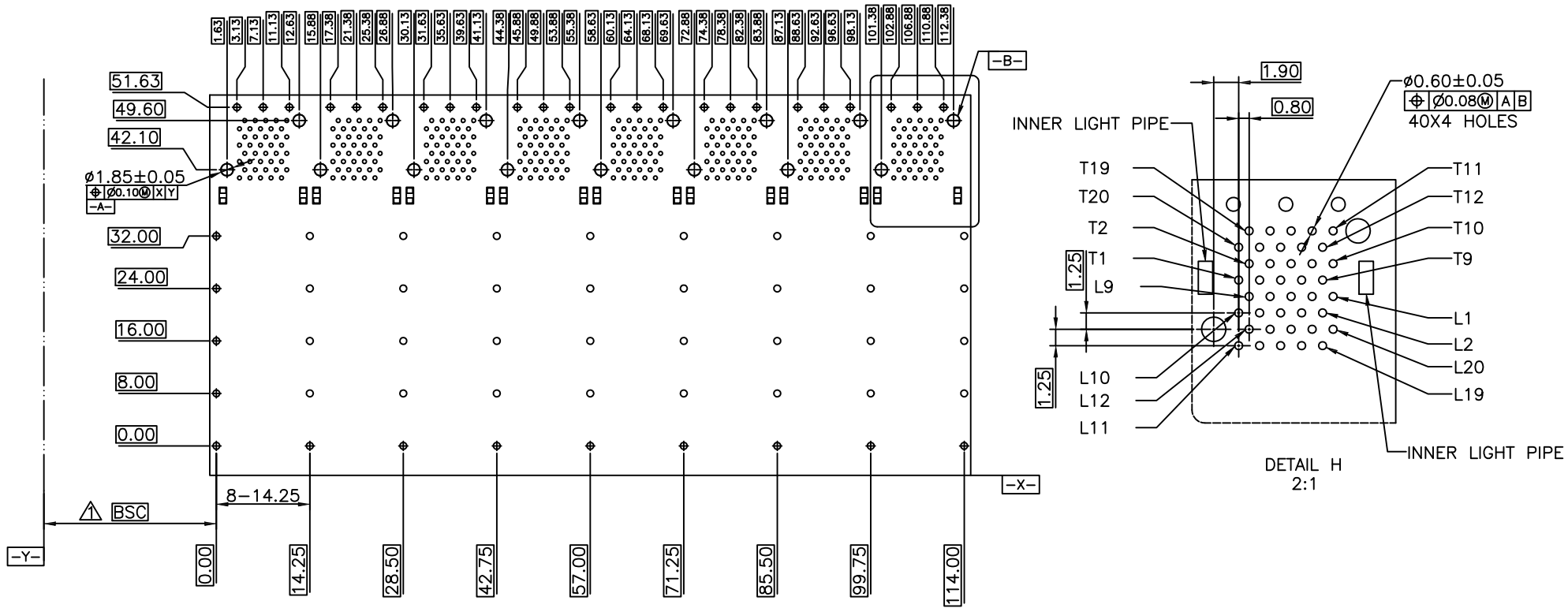

ECOMMENDED PCB CONFIGURATION

NOTES:

- 1. DATUM AND BASIC DIMENSIONS ESTABLISHED BY CUSTOMER.
- 2. 1.05 mm DIAMETER HOLES ARE CHASSIS GROUND (18 HOLES).

				GENERAL TOLERANCE		DRAWN	<i>Sene Li</i>	2017/03/21	UNIT	MM	东莞市祥舜电子科技有限公司 DONGGUAN X-SHUN ELECTRONIC TECHNOLOGY CO., LTD TEL:+86 769 81885389 FAX:+86 769 81887859 E-Mail:sales@x-shun.com Http:www.x-shun.com		
				.X	±0.35	X.°	± 2°	CHECKE	HYY	SCALE		1:1	
A0		NEW DESIGN	2017/03/21			APPROVE				SHEET	3/4	PART NO.	8001-28X015-01
REV	ECN NO	DESCRIPTION	DATE	SIGNATURE	PROJECT	DRAWING NO			REV	A0	TITLE	SFP 2X8 CAGE+CONNECTOR	

RoHS compliant

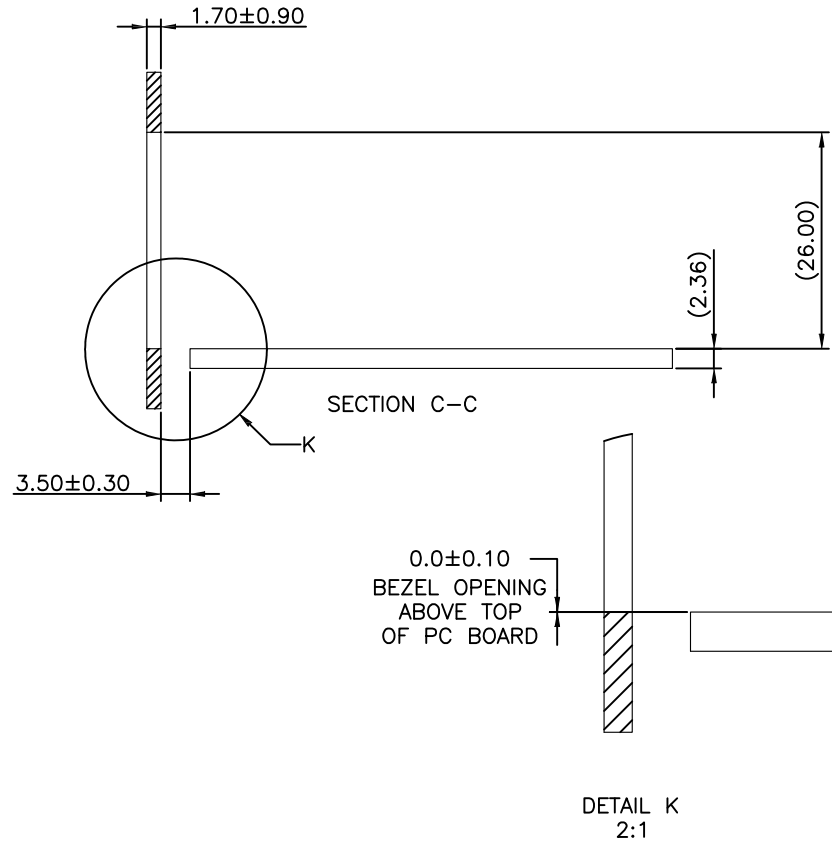
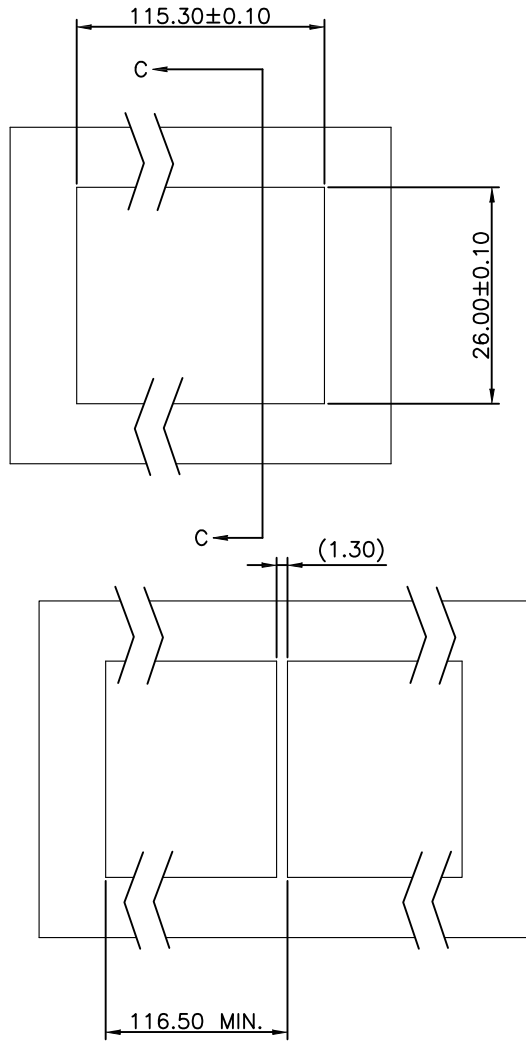

RECOMMENDED BEZEL DESIGN

				GENERAL TOLERANCE		DRAWN	<i>Sene Li</i>	2017/03/21	UNIT	MM	<b>X-SHUN</b> 东莞市祥舜电子科技有限公司 DONGGUAN X-SHUN ELECTRONICTECHNOLOGY CO., LTD TEL:+86 769 81885389 FAX:+86 769 81887859 E-Mail:sales@x-shun.com Http:www.x-shun.com
				.X ±0.35	X.° ± 2°	CHECKE	HYY	SCALE	1:1		
				.XX ±0.25	.X° ± 1°	APPROVE		SHEET	4/4	PART NO.	8001-28X015-01
REV	ECN NO	DESCRIPTION	DATE	SIGNATURE	PROJECT	DRAWING NO		REV	A0	TITLE	SFP 2X8 CAGE+CONNECTOR

A

A