

RoHS compliant

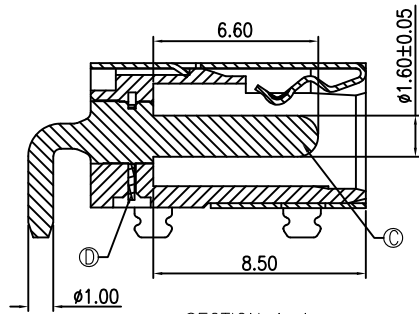

SECTION A-A

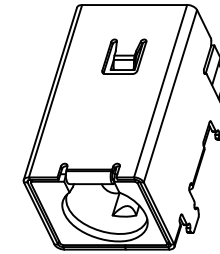
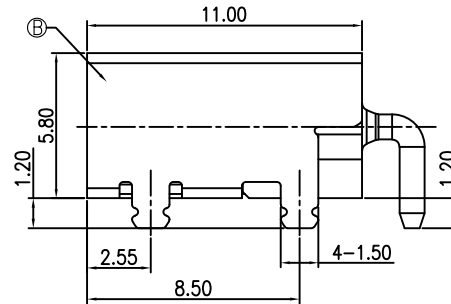
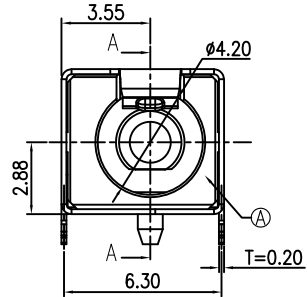

SPECIFICATION:

1. RATING: DC 20V 5A
2. CONTACT RESISTANCE: 30mΩ MAX.
3. INSULATION RESISTANCE: 100 MΩ MIN.
4. WITHSTAND VOLTAGE: 500 VAC
5. INSERTION FORCE: 40N MAX.
6. EXTRACTION FORCE: 3N MIN.
7. DURABILITY: 5,000 CYCLES

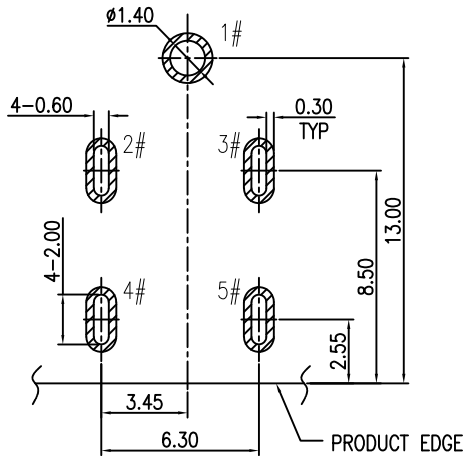
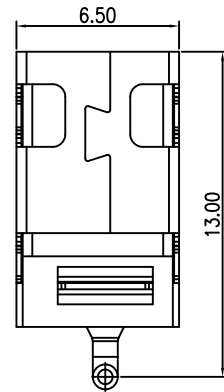

RECOMMENDED PCB LAYOUT(T=1.00)
TOP VIEW TOLERANCE:±0.05

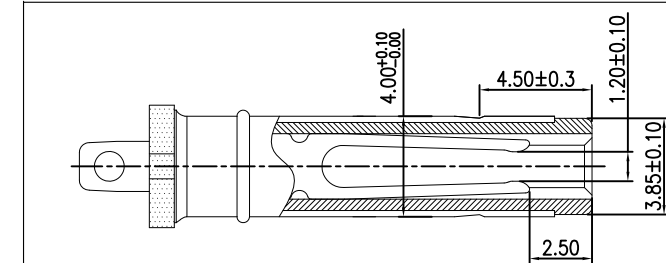

MATING PLUG
P/N.:DP400170-0001-60000H

NO.	DESCRIPTION	MATERIAL	REMARKS	QTY
D	STOPPER	SUS		1
C	CENTER PIN	BRASS	Sn100u"/Ni 50u"	1
B	SHELL	COPPER ALLOY	Ni 50u"	1
A	HOUSING	HIGH TEMP.THERMOPLASTIC	BLACK	1

REV	ECN NO	DESCRIPTION	DATE	SIGNATURE	PROJECT	UNIT	mm	SCALE	1:1	SHEET	REV	A0	DRAWING NO.	H-DC-01
A0		NEW DESIGN	2018/09/22											

GENERAL TOLERANCE

.X ±0.35 X.° ± 2°
.XX ±0.25 .X.° ± 1°
.XXX ±0.15 .XX° ± 0.5°

DRAWN *Sena Li* 2018/09/22

CHECKE SHZ

APPROVE

X-SHUN 东莞市祥舜电子科技有限公司
DONGGUAN X-SHUN ELECTRONIC TECHNOLOGY CO., LTD

PART NO. DC400170-0053-20000H

TITLE: Φ4.0板上型 DC POWER JACK